

ES1-N

Measure Workpieces without Physical Contact Non-damaging, Sanitary, and Efficient Temperature Management

- Measurement temperature -50 to 500°C and -50 to 1,000°C types are available.
- High accuracy and fast measurement with $\pm 0.5^\circ\text{C}$ reproducibility and a 0.14-second (95%) response time.
- You can use the ES1-TOOLS dedicated software (free download from our website) as a setting tool to monitor temperature and change the emissivity, moving average function, and output range.
- Full lineup of laser pointer types.



 Refer to *Safety Precautions* on 7.

Ordering Information

Type	Measurement temperature range	Target size *1	Model
Without laser pointer	-50 to 500°C *2	3 mm dia. (at a distance of 30 mm)	ES1-LP3-N
		8 mm dia. (at a distance of 100 mm)	ES1-LP10-N
		40 mm dia. (at a distance of 500 mm)	ES1-LW50-N
With laser pointer	-50 to 1,000°C *2	35 mm dia. (at a distance of 1,000 mm)	ES1-LW100-N
		40 mm dia. (at a distance of 500 mm)	ES1-LW50L-N
		35 mm dia. (at a distance of 1,000 mm)	ES1-LW100L-N

*1. This value is based on the 90% energy limit. The actual target object must be at least 1.5 times larger than this size.

*2. By default, the measurement range is 0 to 500°C, but you can change the range to -50 to +500°C or -50 to +1,000°C on the ES1-TOOLS.

Ratings and Specifications

Item	Type Model	Without laser pointer				With laser pointer		
		ES1-LP3-N	ES1-LP10-N	ES1-LW50-N	ES1-LW100-N	ES1-LW50L-N	ES1-LW100L-N	
Detection element		Thermopile						
Lens		Silicon						
Measurement wavelength		8 to 14 μm						
Current output	USB output	Resolution: Approx. 0.1°C						
	Current output	4 to 20 mA, -50 to 500°C *1 Load impedance: 250 Ω max. Resolution: Approx. 0.24 μA		4 to 20 mA, -50 to 1,000°C *1 Load impedance: 250 Ω max. Resolution: Approx. 0.24 μA		4 to 20mA/-50 to 500°C *1 Load impedance: 250 Ω max. Resolution: Approx. 0.24 μA		4 to 20 mA, -50 to 1,000°C *1 Load impedance: 250 Ω max. Resolution: Approx. 0.24 μA
Power supply voltage		12 to 24 VDC/USB bus power (Functions other than current output can be used with USB bus power only)						
Allowed power supply voltage fluctuation		95% to 105% of the power supply voltage						
Current consumption		30 mA max. (24 VDC)				<ul style="list-style-type: none"> • 30 mA max. (24 VDC, Not using laser pointer) • 40 mA max. (24 VDC, Using laser pointer) 		
Cable length		2 m \pm 5 cm						
Measurement accuracy		USB output <ul style="list-style-type: none"> • Within $\pm(-8\%rdg+1)^\circ\text{C}$ (Measurement temperature: -50 to 0°C) • Within $\pm 1^\circ\text{C}$ (0 to 200°C) • Within $\pm 0.5\%rdg^\circ\text{C}$ (200 to 500°C) Current output <ul style="list-style-type: none"> • Difference from USB output is ($\pm 0.1\%$ of output range) °C or less 		USB output <ul style="list-style-type: none"> • Within $\pm(-8\%rdg+1)^\circ\text{C}$ (Measurement temperature: -50 to 0°C) • Within $\pm 1^\circ\text{C}$ (0 to 200°C) • Within $\pm 0.5\%rdg^\circ\text{C}$ (200 to 1,000°C) Current output <ul style="list-style-type: none"> • Difference from USB output is ($\pm 0.1\%$ of output range) °C or less 		USB output <ul style="list-style-type: none"> • Within $\pm(-8\%rdg+1)^\circ\text{C}$ (Measurement temperature: -50 to 0°C) • Within $\pm 1^\circ\text{C}$ (0 to 200°C) • Within $\pm 0.5\%rdg^\circ\text{C}$ (200 to 500°C) Current output <ul style="list-style-type: none"> • Difference from USB output is ($\pm 0.1\%$ of output range) °C or less 		USB output <ul style="list-style-type: none"> • Within $\pm(-8\%rdg+1)^\circ\text{C}$ (Measurement temperature: -50 to 0°C) • Within $\pm 1^\circ\text{C}$ (0 to 200°C) • Within $\pm 0.5\%rdg^\circ\text{C}$ (200 to 1,000°C) Current output <ul style="list-style-type: none"> • Difference from USB output is ($\pm 0.1\%$ of output range) °C or less
Reproducibility		<ul style="list-style-type: none"> • Within 0.5°C 		<ul style="list-style-type: none"> • Within $\pm 1^\circ\text{C}$ (Measurement temperature: -50 to 0°C) • Within $\pm 0.5^\circ\text{C}$ (0 to 500°C) • Within $\pm 1^\circ\text{C}$ (500 to 1,000°C) 		<ul style="list-style-type: none"> • Within 0.5°C 		<ul style="list-style-type: none"> • Within $\pm 1^\circ\text{C}$ (Measurement temperature: -50 to 0°C) • Within $\pm 0.5^\circ\text{C}$ (0 to 500°C) • Within $\pm 1^\circ\text{C}$ (500 to 1,000°C)
Temperature drift		<ul style="list-style-type: none"> • Within $\pm 0.5^\circ\text{C}/^\circ\text{C}$ (Measurement temperature: -50 to 0°C) • Within $\pm 0.25^\circ\text{C}/^\circ\text{C}$ (Measurement temperature: 0 to 500°C) 		<ul style="list-style-type: none"> • Within $\pm 0.5^\circ\text{C}/^\circ\text{C}$ (Measurement temperature: -50 to 0°C) • Within $\pm 0.25^\circ\text{C}/^\circ\text{C}$ (Measurement temperature: 0 to 500°C) • Within $\pm 0.5^\circ\text{C}/^\circ\text{C}$ (Measurement temperature: 500 to 1,000°C) 		<ul style="list-style-type: none"> • Within $\pm 0.5^\circ\text{C}/^\circ\text{C}$ (Measurement temperature: -50 to 0°C) • Within $\pm 0.25^\circ\text{C}/^\circ\text{C}$ (Measurement temperature: 0 to 500°C) • Within $\pm 0.5^\circ\text{C}/^\circ\text{C}$ (Measurement temperature: 500 to 1,000°C) 		<ul style="list-style-type: none"> • Within $\pm 0.5^\circ\text{C}/^\circ\text{C}$ (Measurement temperature: -50 to 0°C) • Within $\pm 0.25^\circ\text{C}/^\circ\text{C}$ (Measurement temperature: 0 to 500°C) • Within $\pm 0.5^\circ\text{C}/^\circ\text{C}$ (Measurement temperature: 500 to 1,000°C)
Influence of EMS *2	Radiated electromagnetic field immunity	Within $\pm 10^\circ\text{C}$ (80 MHz to 1.0 GHz)						
	Immunity Conducted Disturbance	Within $\pm 10^\circ\text{C}$ (150 kHz to 80 MHz)						
Response time		Current output: 0.14 s max. (95% response, movement average of 1)						
Emissivity setting		Factory setting: 0.95: Can be changed to a value between 0.100 and 1.999 with the setting tool						
Moving average function		Factory setting: 10 Can be changed to a value between 1 and 1,000 with the setting tool		Factory setting: 50 Can be changed to a value between 1 and 1,000 with the setting tool		Factory setting: 10 Can be changed to a value between 1 and 1,000 with the setting tool		Factory setting: 50 Can be changed to a value between 1 and 1,000 with the setting tool
Operating temperature and humidity range		Temperature: 0 to 55°C, Humidity: 35 to 85% (without condensation)						
Storage temperature and humidity range		-20 to 55°C (without condensation)						
Vibration resistance	Malfunction	10 to 55 Hz, 20 m/s ² along 3 axes for 10 min.						
	Destruction	10 to 55 Hz, 0.75-mm single amplitude, along 3 axis for 2 hours						
Degree of protection		None						
Applicable safety standards		CE, KC, FCC, RCM				IEC60825-1, PSC, FDA		
Dimensions		L: 58, W: 32, H: 40 mm		L: 90.3, W: 32, H: 40 mm		L: 60.4, W: 32, H: 40 mm		L: 92.7, W: 32, H: 40 mm
Weight		Approx. 95 g		Approx. 115 g		Approx. 95 g		Approx. 115 g
Standard accessories		User's Manual, Mounting Brackets, Power/output cable (2 m), and Installation Gauge		User's Manual, Mounting Brackets, and Power/output cable (2 m)				

*1. By default, the measurement range is 0 to 500°C, but you can change the range to -50 to +500°C or -50 to +1,000°C on the ES1-TOOLS.

*2. Industrial electromagnetic environment (EN/IEC 61326-1 Table 2)
Measurement error is within $\pm 10^\circ\text{C}$.

Connection Example

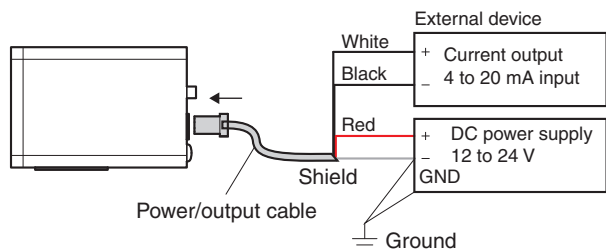

Measurement Field of View

(Unit: mm)

The target size is the diameter of the circle that is equivalent to 90% of the incident power received by the instrument. To measure accurately, the size of the object must be approximate 1.5 to 2 times the target size shown above.

ES1-LP3-N

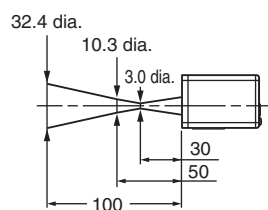

ES1-LW50-N/ES1-LW50L-N

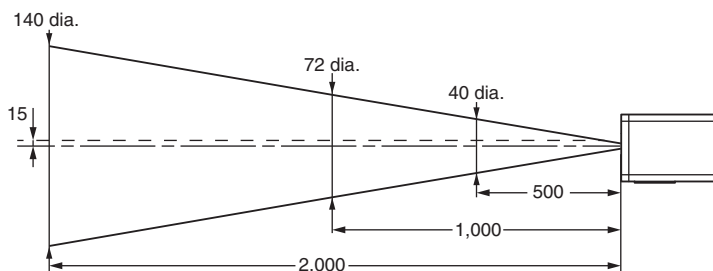

ES1-LP10-N

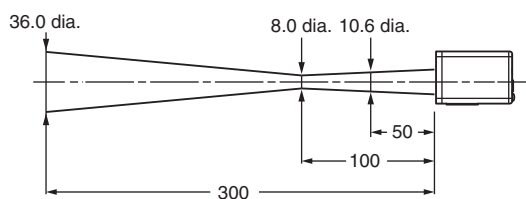

ES1-LW100-N/ES1-LW100L-N

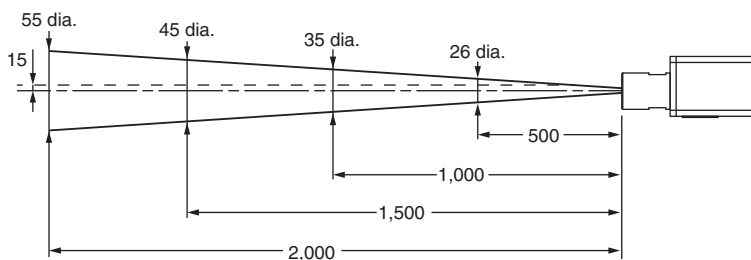

Note: Upper value is the target size, lower value is the distance.
 Long and short dashes line is the center of target.
 Short dashes line is the center of laser pointer.

Dimensions

ES1-LP3-N/ES1-LP10-N

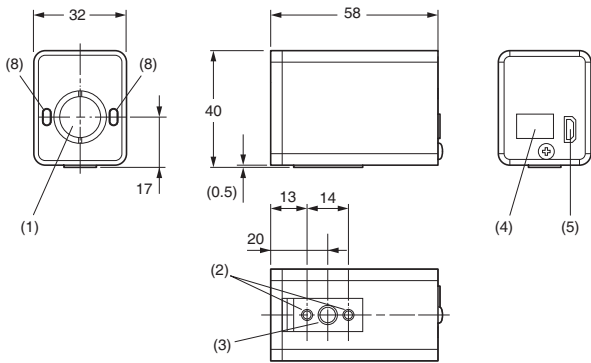

ES1-LW50-N/ES1-LW50L-N

(The ES1-LW50-N does not have the Laser output port (6) and the laser switch (7).)

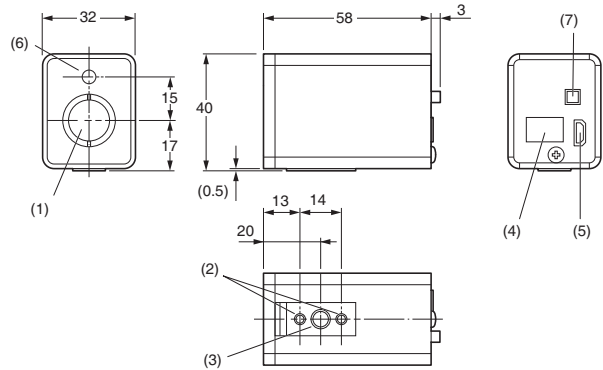

ES1-LW100-N/ES1-LW100L-N

(The ES1-LW100-N does not have the Laser output port (6) and the laser switch (7).)

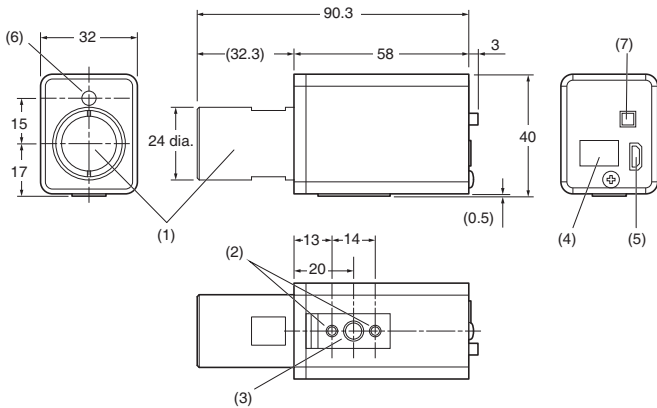

No.	Name
(1)	Lens
(2)	Built-in screws for mounting bracket (M4)
(3)	Built-in screw for tripod (1/4-20UNC)
(4)	Power/output connector
(5)	Micro USB connector
(6)	Laser output port
(7)	Laser switch
(8)	Setting gauge fixing holes

Installation

- To attach the unit to the mounting brackets, use the provided M4x6 screws. Using screws longer than 8 mm may damage the unit.
- The mounting bracket pair to which the bent way is opposite. The body can be rotated downward within the range 0° to 45° as well by exchanging the mounting brackets.
- To fasten the mounting brackets to the customer's instrument, refer to the mounting bracket dimensions shown above.

Using the tripod

Mount on the tripod using the tripod screw holes on the bottom of the unit.

Using the mounting brackets

Attach the unit to the mounting brackets using the mounting bracket screw holes on the bottom of the unit. By combining the mounting brackets as shown below, the unit can be adjusted to any upward angle between 0 and 45°. Loosen the mounting bracket assembly screws and adjust the angle. When finished, tighten the screws.

Mounting bracket assembly example

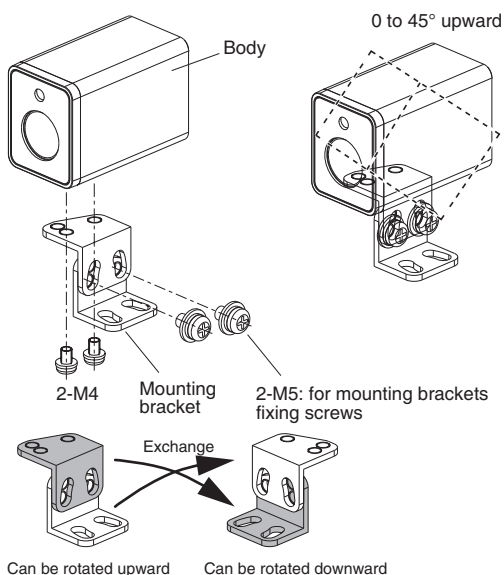

Mounting bracket dimensions (top view)

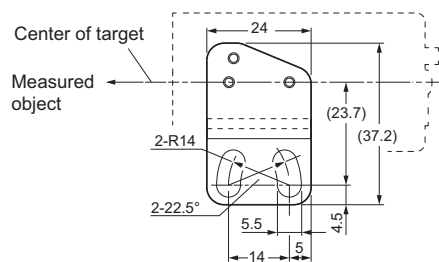

To fasten the mounting brackets to the customer's instrument, refer to the mounting bracket dimensions shown above.

The mounting bracket pair to which the bent way is opposite. The body can be rotated downward within the range 0° to 45° as well by exchanging the mounting brackets.

You can construct a total temperature management and control system by connecting this Sensor to other components.

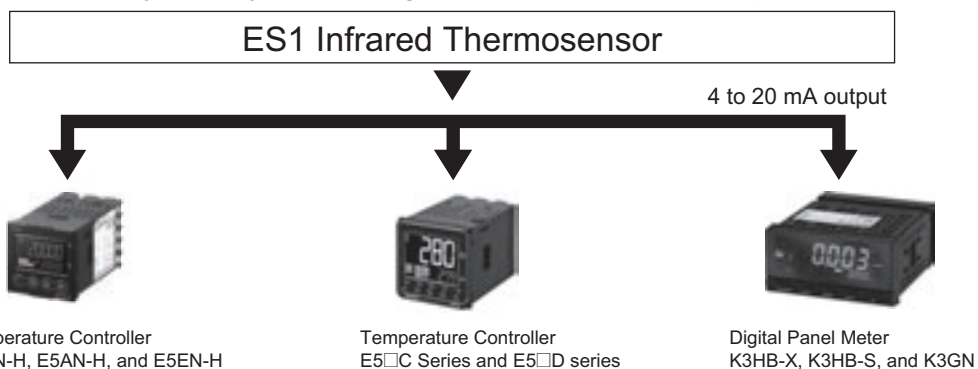

Application Examples

Measurement of Cookie, Biscuit, or Bread Temperatures

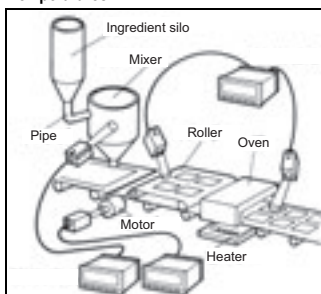

Measurement of Injection Molding and Resin Extraction Machinery Temperatures

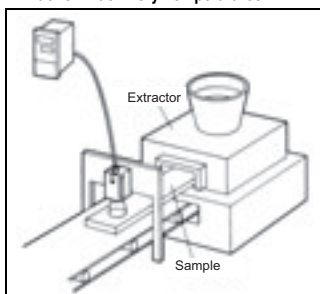

Rubber or Resin Conveyor Belt Temperature Control

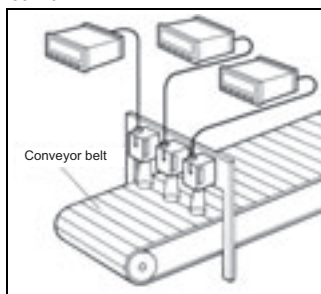

Bearing Heat Production

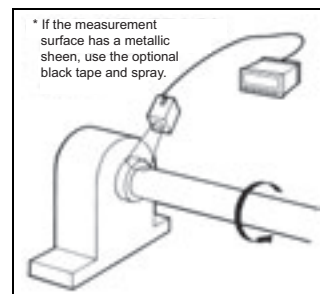

Fiber Drying Process and Printing

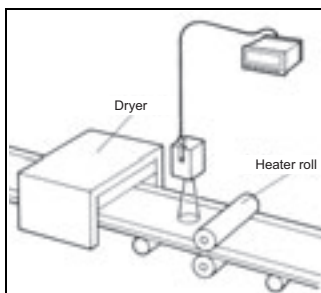

Checking for Poor Contacts on a Switchboard

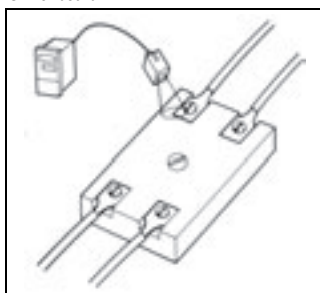

Temperature Control during the Gluing Process of Product Manufacturing

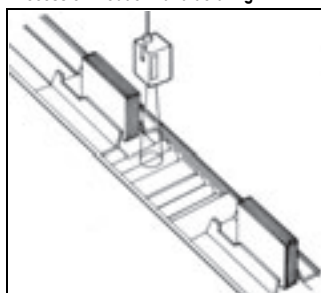

Thermal Insulation Quality Control

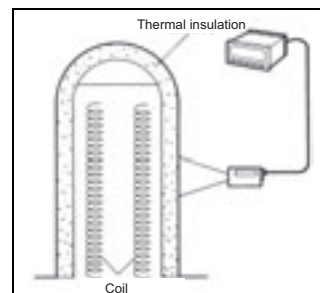

Options

Black Spray/Black Tape

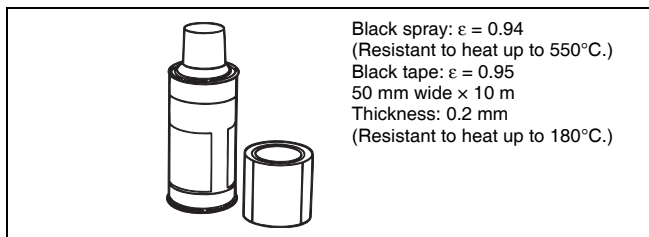

Black spray: $\epsilon = 0.94$
 (Resistant to heat up to 550°C.)
 Black tape: $\epsilon = 0.95$
 50 mm wide x 10 m
 Thickness: 0.2 mm
 (Resistant to heat up to 180°C.)

Name	Model
Black Spray	ES1-S
Black Tape	ES1-T

Use the Black Tape or Black Spray to measure the temperature of objects with a low or unknown emissivity.

Measuring Objects with Low Emissivity

1. Put Black Tape (emissivity: 0.95) on the area you want to measure the temperature of.
2. Set the emissivity of the Infrared Thermosensor to 0.95, then perform the measurement.

Measuring Objects with an Unknown Emissivity

1. Put Black Tape (emissivity: 0.95) on the area you want to measure the temperature of.
2. Set the emissivity of the Infrared Thermosensor to 0.95, then perform the measurement.
3. Remove the tape and measure the temperature. Set the emissivity on the Infrared Thermosensor so that the temperature measures the same as when the tape was on the object.

ES1-TOOLS Data Collection Software Specifications

Supported models	ES1-N series	
Functions	Monitoring and collecting measurement data, checking and changing settings (emissivity, output range lower limit, output range upper limit, moving average data count), auto emissivity setting, current output test	
Usable computer	OS	Microsoft Windows 7/8/8.1/10 (32-bit, 64-bit)
	Hard disk	At least 1 GB of free space
	Display	1280 x 800 dots or higher recommended
Connection method	Connect the ES1-N to the computer using a micro USB cable *	
Language	Japanese, English	

* Prepare the USB cable for connecting to the PC by the customer.

You can download the ES1-TOOLS Data Collection Software for Windows computers from our website.

URL <http://www.ia.omron.com>



This software provides the following functions.

- Checking and changing settings
- Automatic emissivity setting
- Current output test
- Measurement data collection (maximum of 8 units can be connected)

Safety Precautions

Be sure to read the precautions for all Infrared Thermosensors in the website at: <http://www.ia.omron.com/>.

Key to Warning Symbols

 WARNING	Indicates a potentially hazardous situation which, if not avoided, will result in minor or moderate injury, or may result in serious injury or death. Additionally there may be significant property damage.
 CAUTION	Indicates a potentially hazardous situation which, if not avoided, is likely to result in minor or moderate injury or property damage.

Meaning of Product Safety Symbols

	Indicates the possibility of the risk of laser beam exposure
	Indicates prohibitions when there is a possibility of injury, such as from electric shock, as the result of disassembly
	Indicates possibility of electric shock under specific conditions
	Indicates non-specific general prohibitions
	Indicates non-specific general cautions, warnings, and dangers
	Indicates the possibility of injury by high temperature under specific conditions

Warning Symbols

WARNING

The ES1-LW50L-N and ES1-LW100L-N contain a Class 1 laser. Never look at the laser light or allow the laser light to enter the eye. Do not allow laser light reflected from a mirror to enter the eye.



Never disassemble the product. Risk of vision impairment or blindness from laser light leakage if disassembled.



Caution

Minor injury due to electric shock may occasionally occur. Do not touch the connections such as the temperature controller while power is being supplied.



Make sure that the product's metal enclosure is not touching the voltage-applied conductors. For touching the product's metal enclosure with bare hands, electrical shock may occur. The product's metal enclosure and internal circuits, the power supply, current output, or USB port are not isolated.



Electric shock, fire, or malfunction may occasionally occur. Do not allow metal objects, conducting wires, shavings or powder from installation work, water, or other foreign objects to enter the product.



Do not use the product where subject to flammable or explosive gas. Otherwise, minor injury from explosion may occasionally occur.



Never disassemble, modify, or repair the product or touch any of the internal parts. Minor electric shock, fire, or malfunction may occasionally occur.



If the output relays are used past their life expectancy, burning may occasionally occur. Always consider the application conditions and use the output relays within their rated load and electrical life expectancy.



When measuring an object at high temperature, keep the sensor a sufficient distance away from the object and measure within ambient temperature.



- The setting gauge is flammable. Do not allow flame or fire near the setting gauge.
 - If the object of measurement is at high temperature, do not use the setting gauge.
 - Use the setting gauge only after the temperature of the object of measurement has cooled to normal temperature.
- 

Precautions for Safe Use

Be sure to observe the following precautions to prevent operation failure, malfunction, or adverse affects on the performance and functions of the product. Not doing so may occasionally result in unexpected events. Do not handle the product in way that exceed the ratings.

1. The product is designed for indoor use only. Do not use the product outdoors. Do not use or store the product in any of the following locations.
 - Places directly subject to heat radiated from heating equipment.
 - Places subject to splashing liquid or oil atmosphere.
 - Places subject to direct sunlight.
 - Places subject to intense temperature change.
 - Places subject to icing and condensation.
 - Places subject to vibration and large shocks.
 - Places subject to dust or corrosive gas (in particular, sulfide gas and ammonia gas).
2. Use and store the Infrared Thermosensor within the rated ambient temperature and humidity. Provide forced-cooling if required.
3. Check the signal names and polarities of terminals such as those of the temperature controller, and wire correctly.
4. Allow as much space as possible between the controller and devices that generate a powerful high-frequency or surge. Separate the high-voltage or large-current power lines from other lines, and avoid parallel or common wiring with the power lines when you are wiring to the terminals.
5. Use this product within the rated load and power supply voltage.
6. Touching the lens with a hard object or applying stress to the lens may damage the lens and cause the product to malfunction. Do not touch the lens with a hard object or apply stress to the lens.
7. Never use water, detergents, or organic solvents other than absolute alcohol.
8. When disassembling the Infrared Thermosensor for disposal, use suitable tools.
9. The laser pointer uses a semiconductor laser. Shining the laser for an unnecessarily long time may shorten the life of the laser and cause product failure.
10. Risk of damage if pressed with excessive force. When connecting the connector, make sure the orientation is correct and connect correctly.
11. Do not connect/disconnect the USB cable during regular use. Doing so may result in malfunction or failure of the product.

Terms and Conditions Agreement

Read and understand this catalog.

Please read and understand this catalog before purchasing the products. Please consult your OMRON representative if you have any questions or comments.

Warranties.

- (a) Exclusive Warranty. Omron's exclusive warranty is that the Products will be free from defects in materials and workmanship for a period of twelve months from the date of sale by Omron (or such other period expressed in writing by Omron). Omron disclaims all other warranties, express or implied.
- (b) Limitations. OMRON MAKES NO WARRANTY OR REPRESENTATION, EXPRESS OR IMPLIED, ABOUT NON-INFRINGEMENT, MERCHANTABILITY OR FITNESS FOR A PARTICULAR PURPOSE OF THE PRODUCTS. BUYER ACKNOWLEDGES THAT IT ALONE HAS DETERMINED THAT THE PRODUCTS WILL SUITABLY MEET THE REQUIREMENTS OF THEIR INTENDED USE.

Omron further disclaims all warranties and responsibility of any type for claims or expenses based on infringement by the Products or otherwise of any intellectual property right. (c) Buyer Remedy. Omron's sole obligation hereunder shall be, at Omron's election, to (i) replace (in the form originally shipped with Buyer responsible for labor charges for removal or replacement thereof) the non-complying Product, (ii) repair the non-complying Product, or (iii) repay or credit Buyer an amount equal to the purchase price of the non-complying Product; provided that in no event shall Omron be responsible for warranty, repair, indemnity or any other claims or expenses regarding the Products unless Omron's analysis confirms that the Products were properly handled, stored, installed and maintained and not subject to contamination, abuse, misuse or inappropriate modification. Return of any Products by Buyer must be approved in writing by Omron before shipment. Omron Companies shall not be liable for the suitability or unsuitability or the results from the use of Products in combination with any electrical or electronic components, circuits, system assemblies or any other materials or substances or environments. Any advice, recommendations or information given orally or in writing, are not to be construed as an amendment or addition to the above warranty.

See <http://www.omron.com/global/> or contact your Omron representative for published information.

Limitation on Liability; Etc.

OMRON COMPANIES SHALL NOT BE LIABLE FOR SPECIAL, INDIRECT, INCIDENTAL, OR CONSEQUENTIAL DAMAGES, LOSS OF PROFITS OR PRODUCTION OR COMMERCIAL LOSS IN ANY WAY CONNECTED WITH THE PRODUCTS, WHETHER SUCH CLAIM IS BASED IN CONTRACT, WARRANTY, NEGLIGENCE OR STRICT LIABILITY.

Further, in no event shall liability of Omron Companies exceed the individual price of the Product on which liability is asserted.

Suitability of Use.

Omron Companies shall not be responsible for conformity with any standards, codes or regulations which apply to the combination of the Product in the Buyer's application or use of the Product. At Buyer's request, Omron will provide applicable third party certification documents identifying ratings and limitations of use which apply to the Product. This information by itself is not sufficient for a complete determination of the suitability of the Product in combination with the end product, machine, system, or other application or use. Buyer shall be solely responsible for determining appropriateness of the particular Product with respect to Buyer's application, product or system. Buyer shall take application responsibility in all cases.

NEVER USE THE PRODUCT FOR AN APPLICATION INVOLVING SERIOUS RISK TO LIFE OR PROPERTY OR IN LARGE QUANTITIES WITHOUT ENSURING THAT THE SYSTEM AS A WHOLE HAS BEEN DESIGNED TO ADDRESS THE RISKS, AND THAT THE OMRON PRODUCT(S) IS PROPERLY RATED AND INSTALLED FOR THE INTENDED USE WITHIN THE OVERALL EQUIPMENT OR SYSTEM.

Programmable Products.

Omron Companies shall not be responsible for the user's programming of a programmable Product, or any consequence thereof.

Performance Data.

Data presented in Omron Company websites, catalogs and other materials is provided as a guide for the user in determining suitability and does not constitute a warranty. It may represent the result of Omron's test conditions, and the user must correlate it to actual application requirements. Actual performance is subject to the Omron's Warranty and Limitations of Liability.

Change in Specifications.

Product specifications and accessories may be changed at any time based on improvements and other reasons. It is our practice to change part numbers when published ratings or features are changed, or when significant construction changes are made. However, some specifications of the Product may be changed without any notice. When in doubt, special part numbers may be assigned to fix or establish key specifications for your application. Please consult with your Omron's representative at any time to confirm actual specifications of purchased Product.

Errors and Omissions.

Information presented by Omron Companies has been checked and is believed to be accurate; however, no responsibility is assumed for clerical, typographical or proofreading errors or omissions.

OMRON Corporation Industrial Automation Company

Kyoto, JAPAN

Contact: www.ia.omron.com

Regional Headquarters

OMRON EUROPE B.V.

Wegalaan 67-69, 2132 JD Hoofddorp
The Netherlands
Tel: (31)2356-81-300/Fax: (31)2356-81-388

OMRON ELECTRONICS LLC

2895 Greenspoint Parkway, Suite 200
Hoffman Estates, IL 60169 U.S.A.
Tel: (1) 847-843-7900/Fax: (1) 847-843-7787

OMRON ASIA PACIFIC PTE. LTD.

No. 438A Alexandra Road # 05-05/08 (Lobby 2),
Alexandra Technopark,
Singapore 119967
Tel: (65) 6835-3011/Fax: (65) 6835-2711

OMRON (CHINA) CO., LTD.

Room 2211, Bank of China Tower,
200 Yin Cheng Zhong Road,
PuDong New Area, Shanghai, 200120, China
Tel: (86) 21-5037-2222/Fax: (86) 21-5037-2200

Authorized Distributor:

© OMRON Corporation 2017 All Rights Reserved.
In the interest of product improvement,
specifications are subject to change without notice.

CSM_4_1_0118

Cat. No. H227-E1-01

0717(0717)